

VIEW A

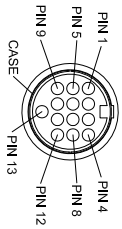

PIN #	WIRE COLOUR	DESCRIPTION
1	THIN PINK	CAM 2 VIDEO
2	THIN SKY BLUE	CAM 2 +12V OUT
3	THIN BROWN	CAM 1 TRIGGER
4	THIN ORANGE	CAM 2 AUDIO
5	THIN YELLOW	CAM 1 VIDEO
6	THIN VIOLET	CAM 1 +12V OUT
7	THIN BLUE	CAM 2 TRIGGER
8	THIN GREEN	CAM 1 AUDIO
9	THIN GREY	NO CONNECTION
10	THICK RED	+12ZAV
11	THICK RED	GND (SHIELD)
12	THICK GREEN	GND (SHIELD)
13	THIN GREEN	+12ZAV
CASE		GND (SHIELD)

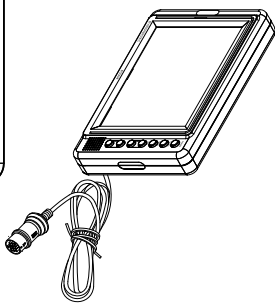
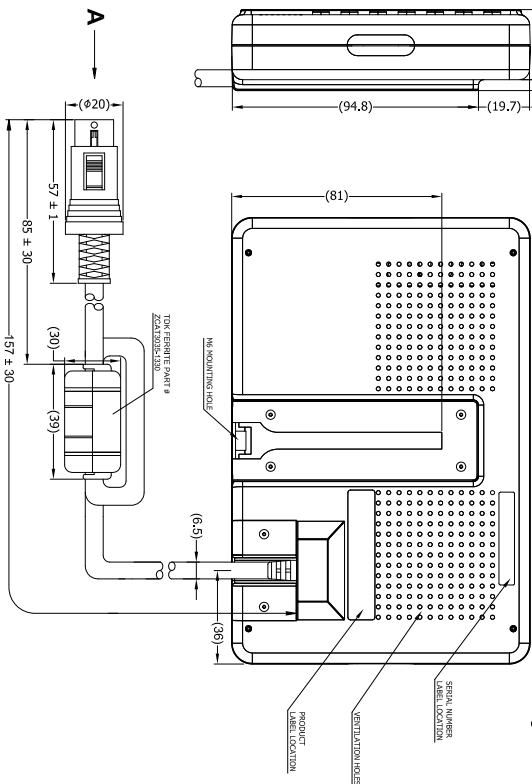
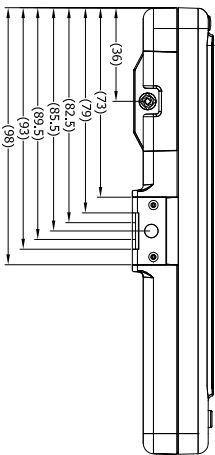
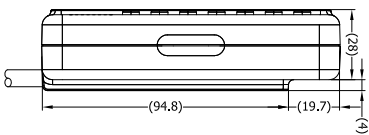
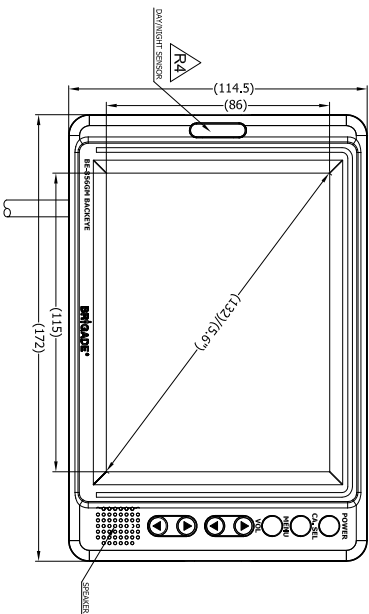
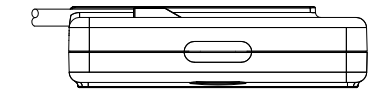
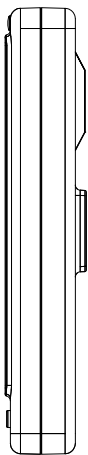

Revision Notes			
R1 - UPDATED CABLE LENGTH.	Drawn: -	Checked: J.NEWMAN	Approved: D.KERAL
APPA: I:CH00	Drawn: -	Checked: J.NEWMAN	Approved: D.KERAL
R2 - SOFTWARE LEVEL ADDED AS PER ECR CR-A250.	Drawn: RBATES	Checked: MBUTLER	Approved: G.PUTH
APPA: I:CH00	Drawn: RBATES	Checked: MBUTLER	Approved: G.PUTH
R3 - LABEL DETAILS IN NOTES UPDATED.	Drawn: RBATES	Checked: A.FEDRIGHI	Approved: G.PUTH
APPA: I:CH00	Drawn: RBATES	Checked: A.FEDRIGHI	Approved: G.PUTH
R4 - IR RECEIVER DETAIL REMOVED FROM DRAWING AS PER ECR CR-A538.	Drawn: MBUTLER	Checked: R.PENITELY	Approved: B.JOHN
APPA: I:CH00	Drawn: MBUTLER	Checked: R.PENITELY	Approved: B.JOHN
			Date: 21/07/17

NOTES:

1. FOR PRODUCT LABEL REFER TO LATEST REVISION OF DRAWING BE-002900-XX-14.
2. FOR SERIAL NUMBER LABEL REFER TO LATEST REVISION OF DRAWING BE-001655-XX-11.
3. FINISH: DARK GREY SPRAY.
4. MATERIAL: ABS PLASTIC.
5. SOFTWARE LEVEL: FIRMWARE VERSION - REV 2.5a & CHECKSUM NO. - 5066.

PROPRIETARY NOTICE

THIS DESIGN AND TECHNICAL INFORMATION APPEARING ON THIS DRAWING IS THE PROPERTY OF BRIGADE ELECTRONICS, AND IS DISCLOSED IN CONFIDENCE. IT IS NOT TO BE COPIED, REPRODUCED, REVEALED TO OR EXPLOITED BY OTHERS, EITHER IN WHOLE OR IN PART WITHOUT THE EXPRESS WRITTEN CONSENT OF BRIGADE ELECTRONICS.

BRIGADE
www.brigade-electronics.com

Angle of Projection		Third Angle	
Assembly PI Approval AKIM	Approved by D.KERAL	Checked by J.NEWMAN	Drawn by M.BUTLER
Units mm	Scale N/A	Released 14/10/11	Assembly Ref -
Status RELEASED			BE-856GM-M
Part No #3757			BE-001730-04-11